

# pNeuton® Transport Ventilator

## mini

### Operators Manual

The pNeuton® Ventilator is under US patent protection.  
(Patent # 6,591,835)

pNeuton is a Registered Trademark of the Airon  
Corporation

Copyright © 2012 by Airon Corporation



Manufactured by:



**Airon Corporation**

751 North Drive

Unit 6

Melbourne, Florida 32934

USA

Tel: 888-448-1238 (toll free USA & Canada)

+1-321-821-9433

Fax: +1-321-821-9443

[www.AironUSA.com](http://www.AironUSA.com)



Intertek



Intertek

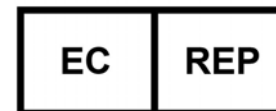

EMERGO EUROPE  
Prinsessegracht 20  
2514 AP The Hague  
The Netherlands

**REF** 97041

CD-I-005 Rev G

Released 8 June 2017

## Table of Contents

Section 1. General Description .....	1-1
Indications for Use .....	1-1
Contraindications .....	1-2
Section 2. Warnings, Cautions, Notes .....	2-1
Warnings .....	2-1
Cautions .....	2-3
Notes .....	2-4
Medical Symbol Key .....	2-7
Section 3. Controls and Patient Safety Systems ..	3-1
Front Panel .....	3-1
Side Panel .....	3-4
Unique Device Identifier.....	3-6
Internal Patient Safety Systems .....	3-7
Section 4. Operating Instructions .....	4-1
Ventilator Set-up .....	4-1
Operational Verification .....	4-2
Patient Ventilation .....	4-3
Inspiratory and Expiratory Time Controls.....	4-4
Peak Pressure and Continuous Flow Controls.	4-5
PEEP/CPAP Control .....	4-6
Oxygen Control .....	4-6
High Pressure Alarm .....	4-6
Disconnect Alarm .....	4-7
Hypobaric Operation .....	4-8
Section 5. Patient Circuit .....	5-1
Infant / Pediatric Circuit .....	5-1
Ventilator Connection .....	5-2
Single-Use only Devices/Accessories .....	5-3
Section 6. Accessories .....	6-1
Section 7. Theory of Operation .....	7-1

Pneumatic System Diagram .....	7-1
Pneumatic System Description .....	7-2
Management of Patient Tidal Volume .....	7-3
CPAP System .....	7-4
Oxygen Delivery System .....	7-5
MRI Compatibility .....	7-7
High Pressure Alarm .....	7-8
Disconnect Alarm .....	7-9
Low Gas Supply Alarm .....	7-10
Section 8. Troubleshooting .....	8-1
Section 9. Cleaning and Maintenance .....	9-1
Cleaning the Ventilator .....	9-1
Cleaning / Disinfecting the Patient Circuit .....	9-1
Routine Maintenance .....	9-1
Factory Preventative Maintenance.....	9-1
Section 10. Specifications .....	10-1
General Description .....	10-1
Ventilator System Performance .....	10-1
Alarm System .....	10-2
Environmental and Physical Characteristics ....	10-3
Power Sources .....	10-3
Section 11. Limited Warranty .....	11-1
Section 12. Index .....	12-1

## **pNeuton mini Transport Ventilator**

### **Section 1: General Description**

The **pNeuton** (pronounced "new-ton") **mini** is a small, lightweight transport ventilator designed for use on patients from neonatal to child in size, 400 grams to 25 kg. It is a time cycled, flow limited ventilator providing Intermittent Mandatory Ventilation (IMV). In this mode of ventilation, an adjustable inspiratory time, expiratory time, and flow are delivered to the patient. The patient is allowed to breath spontaneously between the mandatory breaths with minimal work of breathing. A built-in PEEP / CPAP system can be set to provide expiratory positive pressure. The delivered oxygen is adjustable from 21% to 100%, with oxygen and compressed air as the driving source gas.

The **pNeuton mini** is a pneumatic ventilator. Electrical power is not required for patient ventilation. **mini** has been specifically designed for patient support during transport and non-critical care unit mechanical ventilation. It may be used during intra and inter-hospital transport, in aircraft, on ambulances, in delivery suites, emergency rooms, MRI and other radiology suites.

### **Indications for Use**

The **pNeuton mini** Ventilator is intended for continuous mechanical ventilation of patients in the following patient populations and use locations:

Patient population – neonatal / infant / child patients 400 grams to 25 Kg who require the following general types of ventilatory support:

- positive pressure ventilation delivered invasively (via an ET tube) or non-invasively (via a mask or nasal prongs)

- CMV and IMV modes of ventilation
- with or without PEEP / CPAP
- with oxygen or a mixture of air and oxygen

The ventilator is suitable for use in:

- Inter and intra-hospital patient transport
- Hospital ICU transport applications including delivery rooms, emergency, radiology, surgery, post-anesthesia / recovery and MRI departments
- Air & ground transport – pressurized and non-pressurized aircraft (to 15,000 ft)

### **Contraindications**

The following conditions contraindicate the use of the **pNeuton mini** Ventilator:

- Patients undergoing procedures with flammable anesthetic gasses
- Patients undergoing hyperbaric treatment
- Patients requiring tidal volumes greater than 500 ml.

## Section 2: Warnings, Cautions, Notes

The **pNeuton mini** Ventilator is intended for use by properly trained personnel under the direct supervision of licensed medical Physician or Practitioner only. Personnel must become thoroughly familiar with this Operators Manual prior to using the **pNeuton mini** Ventilator on a patient.

As used in this manual, the following terms mean:

- Warning:** Indicates the possibility for injury to the patient or the operator
- Caution:** Indicates the possibility of damage to the device
- Note:** Places emphasis on an operating characteristic

### Warnings

This manual serves as a reference. The instructions in this manual are not intended to supersede the physician's instructions regarding the use of the **pNeuton mini** Ventilator.

The operator should read and understand this entire manual before using the **pNeuton mini** Ventilator.

 **DO NOT** use the **pNeuton mini** Ventilator in conjunction with anesthetics or in contaminated (hazardous, explosive) atmospheres. Only compressed oxygen and air may be used.

 **DO NOT** use conductive (anti-static) patient breathing circuits. The only approved patient circuits for use with **pNeuton mini** Ventilator are the Airon circuits listed in Section 5 of this manual. Any other patient circuit should **NOT** be used and may lead to patient harm.

Two different diameter patient circuits are used with the **pNeuton mini**, based upon patient size. The 10 mm ID circuit is designed for neonatal and infant patients. The 15 mm ID circuit is designed for children and pediatric patients. **DO NOT** use the 10 mm neonatal circuit on large children or at inspiratory flows of 10 L/min or higher.

 The proper attachment of the circuit's small tubing to the Expiratory Valve and Proximal Pressure connections of the ventilator are very important. Connecting the tubes to the wrong connectors will cause the ventilator to malfunction and not provide ventilation. **DO NOT** cross connect these tubes.

 The Airon patient circuit is a single use, disposable device. Cleaning, reprocessing and / or reuse of this device is not recommended. Reprocessing may cause a change in ventilation characteristics. The circuit and all components are sold clean and non-sterile.

 The Operational Verification tests as described in this manual (Section 4) must be performed prior to connecting a patient to the ventilator. If the ventilator fails any of the tests it must be removed from clinical use. **DO NOT** return the unit to clinical use until all repairs have been completed by an Airon approved repair facility and all operational verification tests are acceptable.

 The **pNeuton mini** Ventilator has been designed for use on neonatal, infant and child patients. The **pNeuton mini** cannot deliver operator adjusted tidal volumes greater than 500 ml. **DO NOT use the pNeuton mini Ventilator on adult patients.**

To protect the patient from high airway pressures, insure that the Peak Pressure control is adjusted appropriately.

 The **pNeuton mini** Ventilator is not intended for use under hyperbaric pressure conditions. If used in these conditions tidal volume delivery will significantly decrease. Careful patient monitoring of tidal volume with a hyperbaric compatible external spirometer is mandatory.

 The **pNeuton mini** Ventilator is MRI Conditional (see Notes section below). While tests show that the ventilator functions at the bore of the MRI unit, Airon Corporation does not recommend that the ventilator be clinically used at or within the bore of MRI scanners. A **minimum** proximity of 12 inches (0.3 meter) from the bore should be used. In addition, safe MRI practice calls for all devices used in the proximity of an MRI scanner, including **pNeuton mini**, be anchored to prevent inadvertent movement.

 The ventilator **will cease to operate** properly if the oxygen supply drops below 40 psi (280 kPa, 2.8 bar). Gas may still flow through the ventilator from the internal blender if the compressed air source is active, but mechanical breaths will cease.

The Low Gas Supply Alarm will occur if the driving gas supply drops below safe levels (40 psi, 280 kPa) or if the difference between the two gas supply pressure is more than 15 psi (100 kPa). The alarm activates as long as driving gas is available or until supply pressure returns to normal. The alarm will only activate for a very short period of time if the gas supply abruptly ceases as can happen if the supply gas becomes disconnected. Always insure that the supply gas is secure and operating at the proper pressure.

## Cautions

Insure that **clean, dry** medical grade compressed air is

used at all times. Compressed air that is contaminated with water or other material will damage the internal components of the ventilator.

**DO NOT** obstruct or cover the holes on the left side of the ventilator where the audible alarm is located. Doing so may decrease the sound level of the audible alarm.

 **DO NOT** attempt to service the unit. Service may only be performed by Airon Corporation authorized engineers. The Preventative Maintenance program requires a general service and calibration every two years. Only original manufacturer parts and accessories should be used.

Any attempts to modify the hardware of this device without the express written approval of Airon Corporation will void all warranties and liabilities.

Do not immerse the **pNeuton mini** Ventilator or allow any liquid to enter the case or the oxygen / medical air inlets. Clean as directed in Section 9, Cleaning and Maintenance.

## Notes

In the USA the **pNeuton mini** Ventilator is a restricted medical device intended for use by qualified medical personnel under the direction of a physician.

During the transport of patients it is recommended that an alternate source of ventilation be available in the event of driving gas supply failure or ventilator malfunction.

 The ventilator will operate normally at altitudes up to 15,000 feet. Changes in altitude will not affect pressure settings but will cause the inspiratory time to increase and the expiratory time to decrease as altitude increases. To

compensate for the effect of changing altitude on tidal volume and respiratory rate, use an external spirometer to verify tidal volume accuracy.

Extremely short inspiratory or expiratory time settings (0.25 seconds) may result in operational variance from the control knob labeling. If using such short time settings, measurement of actual delivered time is recommended.

The **pNeuton mini** Ventilator is MRI Conditional. Non-clinical testing demonstrated that the **pNeuton mini** Infant Ventilator is MR Conditional and can be used in the MRI environment according to the following conditions:



- Static magnetic field of 3-Tesla or less
- Maximum spatial gradient magnetic field of 720 Gauss/cm

**IMPORTANT NOTE:** This product is intended for use within the MRI environment (e.g., in the MR system room). It should not be utilized directly inside of the MR system (e.g., inside of the bore of the scanner), during its operation (i.e., scanning). As such, the assessment of magnetic field interactions for this product specifically involved evaluations of translational attraction and function in relation to exposure to a 3-Tesla MR system only.

Airon recommends that users perform similar tests in their MRI scanner prior to patient use.













Special note on the presence of latex: The components, devices, accessories, and packaging that make up the **pNeuton mini** Ventilator system do not contain any dry natural rubber or natural rubber latex, which may cause allergic reactions.

Special note on the presence of di (2-ethylhexyl) phthalate (DEHP): The components, devices, accessories, and packaging that make up the **pNeuton mini** Ventilator system do not contain any phthalates which are classified

as carcinogenic, mutagenic or toxic to reproduction, of category 1 or 2, in accordance with Annex I to Directive 67/548/EEC.

**Additional Warnings, Cautions, and Notes are located throughout this manual.**

## Airon's Medical Symbol Key

	Consult Instructions of Use
	CE Marked
	Authorized Representative in European Community
	Model (Part) Number
	Lot Number
	Do Not Reuse
	MRI Conditional (3 T)
	Manufacturer
	Manufactured Date
	Use By Date
	Keep Dry
	Caution, serious injury or device damage may occur by disregarding the instructions accompanying this warning symbol.

### Section 3: Controls and Patient Safety Systems

#### Front Panel

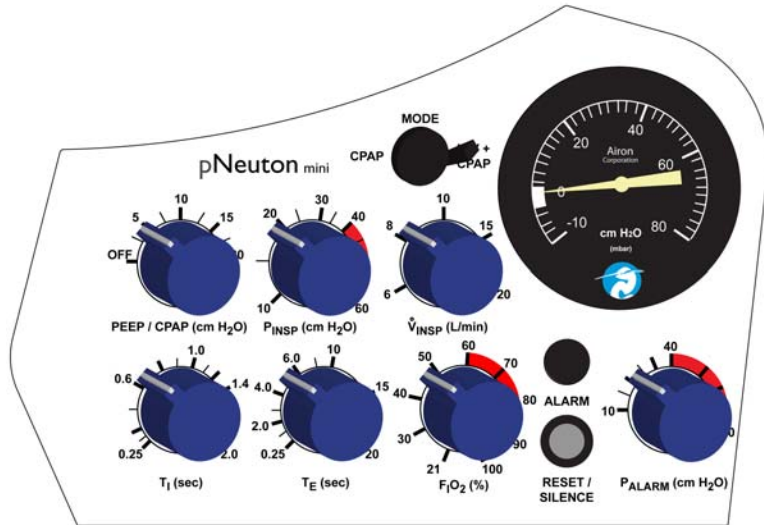

Pressure gauge, patient circuit pressure

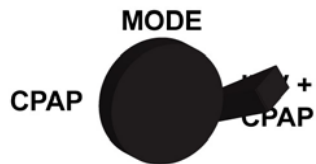

Mode control, puts the ventilator into either the CPAP or IMV + CPAP modes

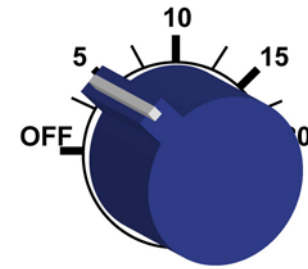

PEEP / CPAP control, calibrated, range 0 to 20 cm H<sub>2</sub>O

PEEP / CPAP (cm H<sub>2</sub>O)

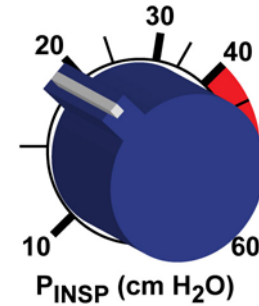

Peak Pressure ( $P_{INSP}$ ) control of mandatory breaths, calibrated, range 15 to 60 cm H<sub>2</sub>O

$P_{INSP}$  (cm H<sub>2</sub>O)

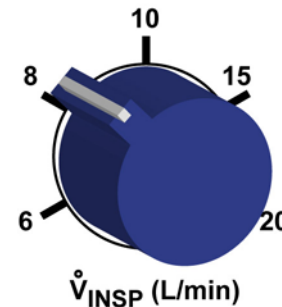

Flow ( $V_{INSP}$ ) control, sets the continuous flow through the patient circuit at 6, 8, 10, 15 or 20 L/min

$V_{INSP}$  (L/min)

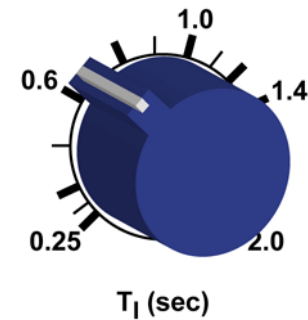

Inspiratory Time ( $T_I$ ) control, calibrated, range 0.25 to 2.0 seconds

$T_I$  (sec)



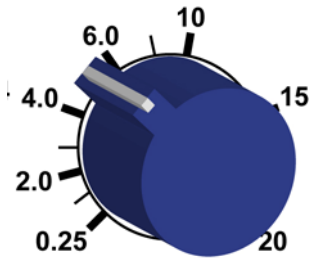

Expiratory Time ( $T_E$ ) control, calibrated, range 0.25 to 20.0 seconds

$T_E$  (sec)

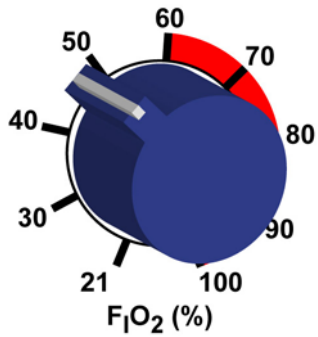

Oxygen ( $F_I O_2$ ) control, calibrated, range 21% to 100%

$F_I O_2$  (%)



Alarm visual indicator

**ALARM**



Alarm Reset / Silence, 10 second alarm, 25 second silence

**RESET / SILENCE**

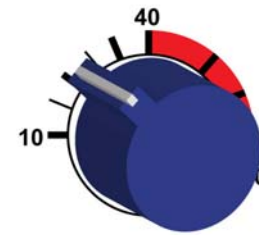

High Pressure Alarm ( $P_{ALARM}$ ) control, range 10 to 70 cm  $H_2O$

$P_{ALARM}$  (cm  $H_2O$ )

### Side Panel

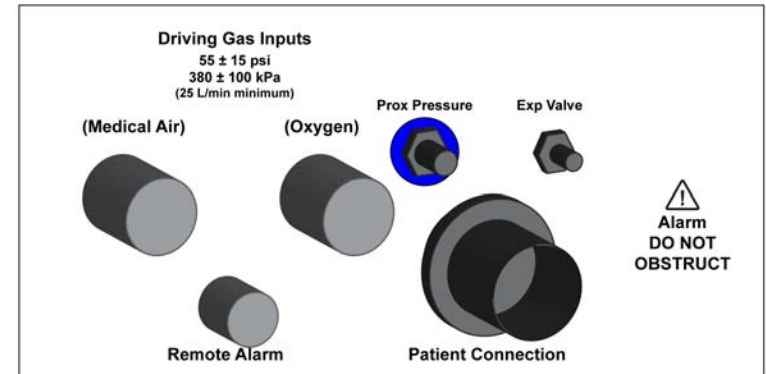

**(Oxygen)**

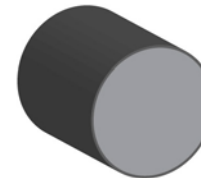

Driving Gas Input (oxygen), requires  $55 \pm 15$  psi ( $380 \pm 100$  kPa,  $3.8 \pm 1$  bar), (25 L/min minimum)

(Medical Air)

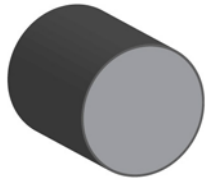

Driving Gas Input (air), requires  $55 \pm 15$  psi ( $380 \pm 100$  kPa,  $3.8 \pm 1$  bar), (25 L/min minimum)



Remote Alarm output

Remote Alarm



Patient Circuit connection, see Section 5 for a complete description of the patient circuit and its attachment to the ventilator

Patient Connection

Exp Valve



Expiratory Valve connection

Prox Pressure



Proximal patient pressure connection

## Unique Device Identification (UDI)

Pursuant to the U.S. FDA Unique Device Identification (UDI) Rule, each device must bear a UDI code. The UDI for pNeuton mini is located under the "Serial Number:" labeling, in plain text, on the back panel of the device. The UDI code consists of one Device Identifier (DI) and potentially four Production Identifiers (PI). Therefore, UDI = DI+PI. Production identifiers are required if the information appears on the product (box) label. The UDI on the product (box) label appears in both plain text and machine-readable format. The numbers in the parentheses indicate different parts of the UDI, as applicable to the device:

- (01) Device Identifier
- (10) Batch / Lot Number
- (11) Manufacturing / Production Date
- (17) Expiration Date
- (21) Serial Number

The format for Manufacturing / Production date and Expiration date within the UDI code is: YYMMDD

- YY = tens and units of the year (e.g. 2014 = 14)
- MM = number of the month (e.g. January = 01)
- DD = number of the day (e.g. third day = 03)
- January 03, 2014 = 140103

An example UDI for the pNeuton mini is as follows:

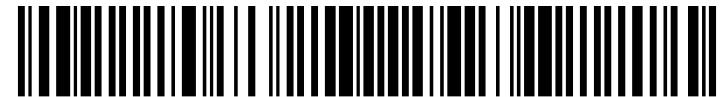

(01)00853678006023(21)I0000

Device Identifier = 00853678006023

Serial Number = I0000

The Device Identifier portion of the code may be entered into AccessGUDID to obtain information about the product.

<http://accessgudid.nlm.nih.gov/>

## Internal Patient Safety Systems

The ventilator has several internal safety systems. These systems insure patient safety in the event of ventilator malfunction.

### High Pressure Release

The patient circuit peak pressure is adjustable using the Peak Pressure control. This control can be set from 15 to 60 cm H<sub>2</sub>O. The factory preset value is 30 cm H<sub>2</sub>O. In addition to this control, there is an internal safety pressure release valve. This valve will automatically limit circuit pressure to approximately 80 cm H<sub>2</sub>O, regardless of the setting of the Peak Pressure control.

### Anti-Suffocation System

An internal safety system will allow the patient to breathe on his or her own in the event of ventilator malfunction. At approximately 2 cm H<sub>2</sub>O negative pressure an internal valve will open allowing unimpeded ambient air to enter the patient circuit for the patient. This system is always available to the patient, irrespective of control settings, including PEEP / CPAP.

### Low Gas Supply Pressure Alarm

When either driving gas supply pressure drops below the safe operating pressure the visual alarm indicator will illuminate and an internal pneumatic audible alarm will sound. This low pressure alarm will occur when the source gas pressure drops below 40 psi (280 kPa) or if the difference between the two gas supply pressure is more than 15 psi (100 kPa). The alarm will continue to sound until all pressure has been lost in the system or when pressure is re-established to at least 45 psi (310 kPa).

 **WARNING:** The ventilator will cease to operate properly if the oxygen supply drops below 40 psi (280 kPa, 2.8 bar). Gas may still flow through the ventilator from the internal blender if the compressed air source is active, but

mechanical breaths will cease.

 **WARNING:** The Low Gas Supply Alarm will only activate for a very short period of time if both gas supplies abruptly cease as can happen if both supply gases become disconnected. Always insure that both supply gases are secure and operating at the proper pressure.

**NOTE:** Always use an external oxygen monitor to insure the desired oxygen percentage is delivered to the patient.

### Disconnect Alarm

The ventilator automatically monitors patient pressure at all times. If there is a disconnection in the patient circuit the visual alarm indicator will illuminate and the audible alarm will sound. The alarm activates if the circuit pressure is less than 3 cm H<sub>2</sub>O for 10 seconds. The Disconnect alarm may be silenced for 25 seconds by pressing the alarm Reset / Silence button.

**NOTE:** Setting the CPAP level to less than 3 cm H<sub>2</sub>O while in the CPAP mode will cause the alarm to sound continuously.

### High Patient Pressure Alarm

During mechanical ventilation the High Patient Pressure alarm will provide an audible and visual alarm when pressure reaches the control's set level. The control can be set independently of the Peak Pressure control. If it is set less than the Peak Pressure control and patient pressure reaches the High Pressure alarm level, it will alarm at every breath. Setting the High Pressure alarm control to a slightly higher level than the Peak Pressure control will notify the operator only when there is inadvertent high patient pressure.

## Section 4: Operating Instructions

### Ventilator Set-up

The following equipment is needed:

1. **pNeuton mini** Ventilator with breathing circuit (see Section 5 for a list of compatible circuits.)
2. Oxygen analyzer
3. Watch

When ready:

1. Attach breathing circuit to ventilator as described in Section 5.
2. Set the controls as follows:
  - a. **Mode** control to IMV + CPAP
  - b. **PEEP / CPAP** to Off
  - c. **Peak Pressure (P<sub>INSP</sub>)** to 30 cm H<sub>2</sub>O
  - d. **Continuous Flow (V<sub>INSP</sub>)** to 8 L/min
  - e. **Inspiratory Time (T<sub>I</sub>)** to 0.6 sec
  - f. **Expiratory Time (T<sub>E</sub>)** to 2.0 sec
  - g. **Oxygen (F<sub>O<sub>2</sub></sub>)** to 60%
  - h. **High Pressure Alarm (P<sub>ALARM</sub>)** to 40 cm H<sub>2</sub>O
3. Occlude the patient connection or place a cap over the patient connection to seal the circuit.
4. Attach Oxygen and Air Input on side panel of the ventilator to high pressure gas sources and turn on the gases.

**NOTE:** The ventilator will begin operation at the above settings when the oxygen and air is turned on. The alarm will sound. You may press the “Reset / Silence” button to silence the alarm or wait for the unit to begin ventilating.

### Operational Verification

Verification Step	Acceptable Range	Result
Observe the pressure gauge. It should rise to 30 cm H <sub>2</sub> O and drop to 0 cm H <sub>2</sub> O.	30 ± 3 cm H <sub>2</sub> O	Pass / Fail
Count the respiratory rate with a stopwatch. Measure the number of breaths in one minute.	23 ± 3 breaths per minute	Pass / Fail
Attach an oxygen analyzer to the output of the expiratory valve. Using a calibrated oxygen analyzer measure the oxygen percentage.	60% ± 3%	Pass / Fail
Set the High Patient Pressure alarm to 20 cm H <sub>2</sub> O. The alarm should activate with each breath.	Visual and audible alarm	Pass / Fail
Remove the patient connection cap and allow the breathing circuit to remain open. Using a stopwatch, measure the time until the alarm sounds.	10 ± 2 seconds	Pass / Fail
Disconnect one gas input with the remaining gas source connected to Air or Oxygen gas source. Verify the Low Gas Supply alarm activates.	Visual and audible alarm	Pass / Fail

If the ventilator has passed all the above steps it is ready for clinical use. If the ventilator fails to pass any of the following tests do not apply it to patients. Call your local distributor or Airon Corporation Customer Support at 888-448-1238 (toll free USA & Canada) or +1-321-821-9433. **Do not attempt to service the unit.**

 **CAUTION:** Do not disassemble the **pNeuton mini** Ventilator. No internal user replaceable parts. All service must be performed by Airon Corporation or an approved service technician. Opening the device will negate the warranty. User will be responsible for all repair costs to service the unit.

## Patient Ventilation

The ventilator operates with the following modes:

- CMV - Continuous Mechanical Ventilation
- IMV - Intermittent Mandatory Ventilation
- CPAP - Continuous Positive Airway Pressure

Using the Intermittent Mandatory Ventilation (IMV) mode, the ventilator provides an adjustable number of breaths per minute using the expiratory time control. The inspiratory time of these breaths is also adjustable. The patient may breathe spontaneously between ventilator breaths as desired.

1. Set the Inspiratory Time ( $T_I$ ) control to the appropriate level.
2. Adjust the Expiratory Time ( $T_E$ ) control to achieve the desired mandatory breath frequency. Refer to the Respiratory rate table on the top of the ventilator for assistance.
3. Set the Oxygen ( $F_I O_2$ ) control to the desired  $F_I O_2$ .
4. Adjust the PEEP / CPAP control to the desired level.
5. Adjust the Peak Pressure ( $P_{INSP}$ ) control to the desired level by turning the control while occluding the patient circuit and observing the level of pressure generated during a mandatory breath.
6. Adjust the Continuous Flow ( $V_{INSP}$ ) control to the desired level. This sets the flow that is used for inspiration. The larger the patient, the higher flow that is needed to meet patient demand.
7. Adjust the High Pressure Alarm ( $P_{ALARM}$ ) control to the

desired alarm level. This setting will determine at which pressure the alarm will activate. It can be set independent of the Peak Pressure control.

8. Set the Mode control to IMV + CPAP.
9. Turn on the gas supplies.
10. Attach the patient circuit to the patient and observe for appropriate ventilation. Adjust as required. External measurement devices may be used to verify ventilation parameters.
11. Observe and monitor the patient and the ventilator per your institution's standards. If using a portable gas supply, monitor the supply level to insure there is sufficient gas for ventilation.

The **pNeuton mini** functions as a pressure-limited ventilator, as such the set inspiratory time, flow and oxygen concentration will remain constant within the complete range of delivered pressures.

## Inspiratory and Expiratory Time Controls

The Inspiratory Time control ( $T_I$ ) sets the time the ventilator delivers a mandatory breath. The range is 0.25 to 2.0 seconds. The longer the set time, the higher the tidal volume. When the set Peak Pressure level is reached the continuous flow through the patient circuit will be released through the expiratory valve.

The Expiratory Time control ( $T_E$ ) sets the time the ventilator does not deliver a mandatory breath. The range is 0.25 to 20.0 seconds. This control is used to set the respiratory rate for mandatory breaths. The patient is allowed to breathe spontaneously during this period.

Respiratory Rate Chart: estimated breaths per minute based upon I Time and E time settings. (See chart below.)

Insp Time (sec)	Exp Time (sec)					
	0.25	2	4	6	10	15
0.25	120	27	14	10	6	4
0.4	92	25	14	9	6	4
0.6	71	23	13	9	6	4
0.8	57	21	13	9	6	4
1.0	48	20	12	9	5	4
1.2	41	19	12	8	5	4
1.4	36	18	11	8	5	4
1.6	32	17	11	8	5	4
1.8	29	16	10	8	5	4
2.0	27	15	10	8	5	4

The patient's breathing efforts cannot affect the timing of mandatory breaths. The mandatory breaths are started when the set expiratory time ends. There is no synchronization of patient effort with the start of mandatory breaths. At the end of the expiratory time the ventilator will switch to inspiration and provide a breath for the set inspiratory time at the set peak pressure.

### Peak Pressure and Continuous Flow Controls

The Peak Pressure control ( $P_{INSP}$ ) sets the maximum pressure that will be generated in the patient circuit. The range is 15 to 60 cm H<sub>2</sub>O. This is a pressure limiting system. When the pressure is reached during inspiration the continuous flow through the patient circuit will then escape out the exhalation valve instead of going into the patient.

The Continuous Flow control ( $V_{INSP}$ ) sets the level of flow through the patient circuit. This is a continuous flow that is maintained at all times. The flow settings are 6, 8, 10, 15 and 20 L/min.

The combination of the Inspiratory Time, Peak Pressure and Flow settings determine the tidal volume delivered. The time of inspiration and the flow through the circuit determines tidal volume as long as the pressure level is not reached. Once the pressure level is reached, flow is then diverted out the exhalation valve and delivered volume to the patient stops. See a complete description of the relationship of these controls to tidal volume delivery in Section 7.

### PEEP / CPAP Control

The PEEP / CPAP control sets the level of PEEP during mandatory ventilation and CPAP during spontaneous breathing. The range is 0 to 20 cm H<sub>2</sub>O. This is a continuous flow system using the expiratory valve to control the pressure level. It functions during all ventilator modes.

### Oxygen Control

The Oxygen Control ( $F_{I}O_2$ ) sets the level of oxygen delivered to the patient. The range is 21% to 100%. The ventilator uses an internal oxygen / air mixing system which provides the continuous flow into the patient circuit. See Section 7 for a complete description of this system. It is recommended that an external oxygen analyzer always be used to verify oxygen delivery.

### High Pressure Alarm

The High Patient Pressure alarm ( $P_{ALARM}$ ) will provide an audible and visual alarm when pressure reaches the control's set level. The range is 10 to 70 cm H<sub>2</sub>O. The control can be set independently of the Peak Pressure control. If it is set less than the Peak Pressure control and patient pressure reaches the alarm level, it will alarm at

every breath. Setting the High Pressure alarm control to a slightly higher level than the Peak Pressure control will notify the operator only when there is inadvertent high patient pressure.

The alarm system provides a remote alarm output on the left side of the ventilator. Use the Airon Remote Alarm (Part number 21031) to provide a remote audible and visual indication of active alarm conditions.

### **Disconnect Alarm**

The ventilator has a patient circuit disconnect alarm system. This system cannot be turned off. If a circuit disconnect is sensed, the visual indicator on the front panel will illuminate and the audible alarm will sound.

The alarm will activate as soon as a gas source is turned on to the ventilator. You may silence the alarm for 25 seconds by pressing the Reset / Silence button. Attaching the ventilator to a patient and starting ventilation will automatically reset the alarm system and turn off the audible and visual indicators.

A patient circuit disconnect is sensed if the pressure in the patient circuit is less than 3 cm H<sub>2</sub>O for 10 seconds. Mandatory breaths of 3 cm H<sub>2</sub>O or greater during the 10 second window will reset the alarm to wait for the next breath. When PEEP / CPAP is turned on and set for at least 3 cm H<sub>2</sub>O no patient breaths are required to satisfy the alarm system.

**NOTE:** Setting the CPAP level to less than 3 cm H<sub>2</sub>O while in the CPAP mode will cause the alarm to sound continuously.

The alarm system can be momentarily silenced by pressing the Reset / Silence button on the front panel. Pressing this

button turns off the visual and audible indicators for 25 seconds. Each time the Reset / Silence button is pressed; the alarm system restarts the 25 second silence time delay. This delay is NOT cumulative. In other words, repeatably pressing the Reset / Silence button will not increase the silence time by more than 25 seconds.

The alarm system provides a remote alarm output on the left side of the ventilator. Use the Airon Remote Alarm (Part Number 21031) to provide a remote audible and visual indication of active alarm conditions.

### **Hypobaric (Altitude) Operation**

The ventilator will operate normally at altitudes up to 15,000 feet. Changes in altitude will not affect pressure settings. However, delivered inspiratory time increases and expiratory time decreases with increasing altitude. This is due to lower barometric pressure than the ventilator's calibration at standard sea level.

To compensate for the effect of changing altitude on inspiratory and expiratory time, use a stopwatch to verify ventilation timing accuracy. Adjust the inspiratory and expiratory time controls to the desired value as measured by the stopwatch rather than the markings on the control panel.

## Section 5: Patient Circuit

### Infant and Pediatric Circuits

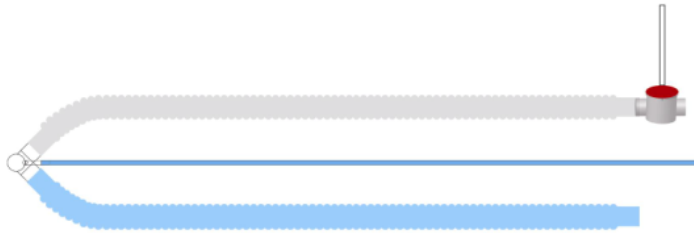

The patient circuits designed for use with the **pNeuton mini** Ventilator are:

- Neonatal to infant patients - part number 58031, 10 mm internal diameter, 4 ft. (1.2 m) length disposable patient circuit.
  - Use 6 or 8 L/min flow setting with this circuit.
  - Compression volume = 0.1 ml per cm H<sub>2</sub>O
- Pediatric patients – part number 58035, 15 mm internal diameter, 4 ft. (1.2 m) length disposable patient circuit.
  - Use 8, 10, 15 or 20 L/min flow setting with this circuit.
  - Compression volume = 0.5 ml per cm H<sub>2</sub>O

**! WARNING:** Patient circuits other than the Airon circuits listed above will alter the ventilator's CPAP / PEEP characteristics and / or expiratory flow resistance. They should **NOT** be used and may lead to patient harm.

**! WARNING:** Do not use air filters on the **expiratory port** of the patient circuit except those provided by Airon Corporation. Some filters may alter the ventilator's CPAP / PEEP characteristics and / or expiratory flow resistance. They should **NOT** be used and may lead to patient harm.

### Ventilator Connection

The patient circuit must be attached to the ventilator properly. Incorrect attachment could result in failure to provide adequate ventilation.

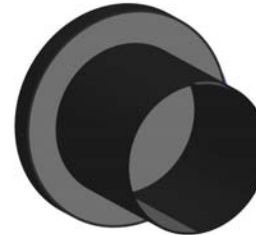

**Patient Connection**

The main breathing hose (22 mm) is connected to the "Patient Connection" port.

**Exp Valve**



The small tubing (3 mm) connects the expiratory valve to the "Expiratory Valve" barb connection

**Prox Pressure**

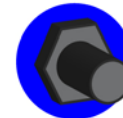

The small blue tubing (4 mm) connects the proximal patient port of the circuit to the blue "Proximal Pressure" barb connection

**! WARNING:** The proper attachment of the circuit's small tubing to the Expiratory Valve and Proximal Pressure connections of the ventilator are very important. Connecting the tubes to the wrong connectors will cause the ventilator to malfunction and not provide ventilation. **DO NOT** cross connect these tubes.

**NOTE:** The Airon patient circuit is a single use, disposable device. Cleaning, reprocessing and / or reuse of this device is not recommended. The circuit and all components are sold clean and non-sterile.



## Single-Use only Medical Devices/Accessories

### How do I know if a device is Single-Use?



This symbol will be identified on the packaging and User's Manual of the device.

### What does Single-Use mean?

Do not reuse. A single-use device is used on an individual patient during a procedure, such as transport ventilation, and then discarded. It is not intended to be reprocessed and used again, even on the same patient.

### What is the concern with reused device labeled Single-Use?

The use of reprocessed devices may present serious incidents relating to the health and safety of patients and healthcare professionals. Reuse can be unsafe because of risk of:

- Cross-infection – inability to clean and decontaminate due to design, device components are not manufactured for disassembly and reassembly
- Endotoxin reaction – excessive bacterial breakdown products, which cannot be adequately removed by cleaning
- Patient injury – device failure from reprocessing or reuse because of fatigue or material alteration
- Chemical burns or sensitization – residues from chemical decontamination agents on materials that can absorb chemicals



**NOTE:** If you reuse a single-use device you may be legally liable for the safe performance of the device.

## Section 6: Accessories

Accessories have been compiled to add safety and an ease of operation and training.

- Patient circuits
- CPAP interfaces
- MRI environment

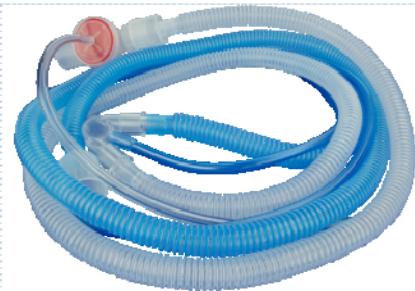

**Neonatal/infant patient circuit-** Box of 15. Disposable, single patient use. 10mm ID, 4 foot (1.2m) length. SAFETY NOTE: Only Airon manufactured patient breathing circuits are approved for use with pNeuton ventilators.

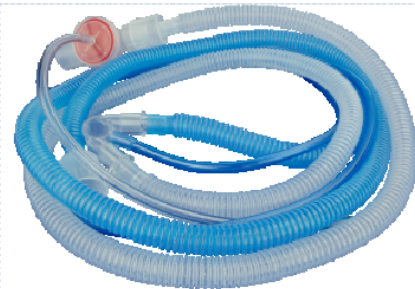

**Child /pediatric patient circuit** – Box of 15. Disposable, single patient use. 15mm ID, 4 foot (1.2m) length. SAFETY NOTE: Only Airon manufactured patient breathing circuits are approved for use with pNeuton ventilators.



**miniFlow nCPAP Patient Interface** – Box of 20. For use with the pNeuton mini.



**miniFlow Start-up Kit** – Small. Disposable, single patient use. Includes 5 miniFlow interfaces, 3 Small nasal prongs, 2 masks, and 3 bonnets.



**miniFlow Start-up Kit -** Large. Disposable, single patient use. Includes 5 miniFlow interfaces, 3 Large nasal prongs, 2 masks, and 3 bonnets.



**miniFlow Nasal Prongs** – Nasal prongs for use with miniFlow system. Box of 10 single use, disposable nasal prongs.



**miniFlow Nasal Mask** – Nasal mask for use with miniFlow system. Box of 10 single use, disposable nasal masks.





**miniFlow Bonnet - Head Bonnet** for use with miniFlow system. Box of 10 single use, disposable bonnets.

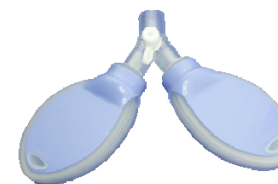

**miniFlow Attachment strip for bonnets** – Attachment strips for use with miniFlow system. Box of 10 single use, disposable strips.

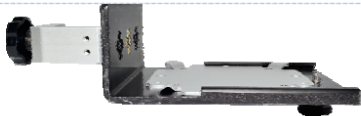

**Test Lung, infant** – A rigid wall Test Lung is ideal to test and demonstrate the performance of the pNeuton mini. Spontaneous breaths can only be properly simulated using a rigid wall test lung.

	<p><b>MRI compatible Mobile Stand, mini</b> – The Mobile Stand is a 3 foot, 9 inch (1.2 m) tall, MRI compatible stand designed to hold the pNeutron mini ventilator. The five wheeled stand uses large 3 inch (7.6 cm) wheels to aid in stability and ease of movement. Four “E” size cylinders (2 medical air, 2 oxygen) can be securely mounted on the stand. The ventilator attaches to the stand using a mounting plate which allows the user to slide the ventilator on and off the stand for transport.</p>
	<p><b>Pole Mount</b> – The mini Pole Mount will allow the ventilator to be mounted to standard horizontal or vertical poles up to 1.25” (3 cm). The mount provides a sturdy support during patient transport. The ventilator attaches to the mount using a mounting plate which allows the user to slide the ventilator on and off the mount.</p>
	<p><b>Remote Alarm</b> Respironics Model 1118941 - Allows the user to attach a remote alarm to the pNeutron Ventilator. Great for the MRI control room.</p>

	<p><b>Remote Alarm Cables</b> MRI compatible BNC cables to attach the remote alarm to the pNeutron Ventilator</p> <p>50 foot (15 m) cable 100 foot (30 m) cable</p>
	<p><b>Oxygen Regulator</b> – A MRI compatible high pressure oxygen regulator for D / E size oxygen tanks.</p>
	<p><b>Medical Air Regulator</b> – A MRI compatible high pressure medical air regulator for D / E size tanks.</p>
	<p><b>Manifold System</b> - A 3-way manifold that connects to the mobile stand and allows for the seamless use of two oxygen cylinders and external oxygen supply to provide continuous power to the pNeutron ventilator. Both systems include 1 oxygen and 1 medical air manifold, 3 x 18” each high pressure air and oxygen hoses and 1 x 10’ each high pressure air and oxygen hoses. The standard manifold also includes 2 each oxygen and medical air regulators.</p>
	<p><b>High Pressure Oxygen Hose</b> - DISS Female both ends, MRI compatible. (Note: ISO color hose available)</p>



**High Pressure Medical Air Hose** - DISS Female both ends, MRI compatible.



**Oxygen Cylinder, E Size**  
– A 600 liter green oxygen cylinder with yoke stem valve



**Medical Air Cylinder, E Size** – A 600 liter yellow medical air cylinder with yoke stem valve

## Section 7: Theory of Operation

The **pNeuton mini** is a pneumatic ventilator based upon the Intermittent Mandatory Ventilation (IMV) principle. As such, adjustable inspiratory timed breaths are delivered to the patient between which the patient may breathe spontaneously. This section describes how the ventilator operates.

Further information on the ventilator's theory of operation, including circuit diagrams, parts lists, and calibration instructions are available from Airon Corporation to properly trained service personnel.

### Pneumatic System Diagram

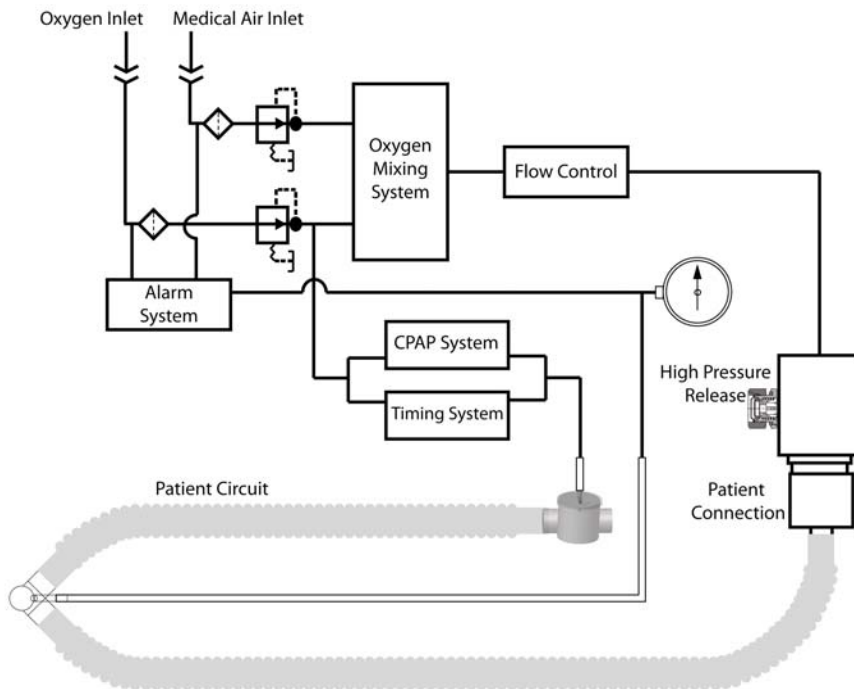

## Pneumatic System Description

The major components of the pneumatic system and the control of gas flow through the ventilator are as follows:

1. High pressure gases, oxygen and medical grade compressed air enters the ventilator and are filtered (5 micron) and reduced to a lower working pressure (40 psi, 280 kPa, 2.8 bar).
2. Both gases go into a high quality oxygen blender where they are mixed per the  $F_{I}O_2$  control setting. This blender provides accurate gas mixing  $\pm 3\%$  throughout the operating range of the ventilator.
3. The output of the oxygen blender goes to the Flow ( $V_{INSP}$ ) control. This device controls the flow of mixed gas to the patient circuit connection.
4. The timing circuit is separately driven by the oxygen source gas and uses two precision control valves to control inspiratory and expiratory time. These valves charge (or reduce) pressure to a pneumatic timing cartridge. This timing cartridge turns on or off the gas supply to the Peak Pressure control system.
5. The Peak Pressure control system sends an adjustable pressure to the patient circuit expiratory valve. The pressure in this system determines the peak pressure that can be generated in the patient circuit.
6. The adjustable PEEP / CPAP system directs a pressure signal to the expiratory valve to generate the PEEP and CPAP levels in the circuit.
7. The circuit pressure measured at the proximal patient port is directed to the pressure gauge and the High Pressure Alarm control. If patient pressure exceeds the control setting a pneumatic signal is sent to activate the audible and visual alarm system. A small amount of gas continuously flows down the patient pressure line to insure it remains open. The gas is at the same oxygen concentration at the oxygen control.

- 8. The proximal patient pressure signal is also sent to the patient disconnect alarm system. See the description later in this section for information on how the alarm functions.

### Management of Patient Tidal Volume through the Inspiratory Time, Flow and Peak Pressure Controls

The combination of the Inspiratory Time, Peak Pressure and Flow settings determine the tidal volume delivered to the patient. There is no set or guaranteed tidal volume. The tidal volume the patient actually receives can vary breath to breath due to many factors including the patient's lung compliance / resistance and leaks around the patient interface.

The time of inspiration and the flow through the circuit is the basic determination of tidal volume (ml). During inspiration the ventilator closes the expiratory valve and the continuous flow is directed into the patient's lungs. The time of inspiration multiplied by the flow equals the tidal volume. The following chart shows the range of tidal volume delivery based on the available control setting:

Insp Time (sec)	Continuous Flow (L/min)				
	6	8	10	15	20
0.25	25	33	42	63	83
0.40	40	53	67	100	133
0.60	60	80	100	150	200
0.80	80	107	133	200	267
1.00	100	133	167	250	333
1.20	120	160	200	300	400
1.40	140	187	233	350	467
1.60	160	213	267	400	533
1.80	180	240	300	450	600
2.00	200	267	333	500	667

The above table assumes that all of the flow from the

ventilator goes to the patient's lungs. This is seldom the case in neonatal and infant ventilation. Gas is often lost around the endotracheal tube or mask interface. Gas can also be lost due to pressure limitation of the exhalation valve. The Peak Pressure control is used to set the highest pressure delivered to the patient. When this pressure in the circuit is reached, all flow during the inspiratory time is then diverted out the exhalation valve. This diverted flow does not contribute to delivered tidal volume.

The Peak Pressure control can be tested by occluding the patient port of the patient circuit during a mandatory breath. During the breath the pressure will rapidly raise to the set peak pressure. The level can be adjusted by turning the Peak Pressure control until the desired peak pressure is achieved.

As when using any mechanical ventilator, careful attention to detail is required. It is suggested that independent validation of tidal volume and rate be performed using external spirometers and timing devices.

### CPAP System

The ventilator's internal CPAP system provides gas for spontaneous breathing at adjustable CPAP pressures up to 20 cm H<sub>2</sub>O. This is a simple continuous flow system. The patient may inhale at any flow rate needed. If the patient's spontaneous inspiratory flow is greater than the set continuous flow, inspiratory pressure may decrease. Adjusting the continuous flow to meet the patient's inspiratory demand will decrease work of breathing.

The PEEP / CPAP control is calibrated to the dynamics of Airon Corporation disposable patient circuit. Using this circuit will insure proper operation and the full 0 to 20 cm H<sub>2</sub>O PEEP / CPAP range.

## Oxygen Delivery System

The **pNeuton mini** ventilator uses a sophisticated oxygen blender to mix oxygen and air for delivery to the patient. This blender requires both compressed oxygen and medical grade air for proper operation. The ventilator should not be used if either gas source is not available.

The required input pressure for each gas is  $55 \pm 15$  psi ( $380 \pm 100$  kPa or  $3.8 \pm 1$  bar). The gas source must be able to maintain the required pressure with flow up to 25 L/min. If the supply pressure decreases below the required pressure due to flow demand, the low gas supply alarm will activate.

The  $F_{I}O_2$  control sets the oxygen / air percent mixture delivered to the patient. The continuous flow rate of this oxygen mixture into the patient circuit is controlled by the Flow ( $V_{INSP}$ ) control. The accuracy of the blender is 3%. If the low gas supply alarm is activated, the delivered oxygen will not be accurate.

Large variance between the pressures of either gas source may affect accuracy of the oxygen blender. The internal pressure regulators reduce both gases to 40 psi for use by the blender. As long as both gases are at the minimum pressure or above the mixing system will operate properly. However, if the gas pressures differ by 15 psi (100 kPa or 1 bar) or more then the accuracy may be affected and the alarm system will activate.

The operation of the internal pneumatic control system does not use the output of the blender. All pneumatics are operated from oxygen only. This insures proper operation, regardless of the percent oxygen being delivered to the patient. If the oxygen supply pressure decreases below the required level, the pneumatic system may malfunction.

 **WARNING:** Never operate the ventilator without proper oxygen and air gas supplies at the required pressure.

 The ventilator **will cease to operate** properly if the oxygen supply drops below 40 psi (280 kPa, 2.8 bar). Gas may still flow through the ventilator from the internal blender if the compressed air source is active, but mechanical breaths will cease.

### Factors Effecting the Operating Time from Tanks

There are several factors that affect the length of time the ventilator will operate from oxygen / air cylinders. The ventilator uses very little gas for its own operation (less than 3 L/min) and is not a major factor in oxygen tank consumption. The major factors are:

- Volume of oxygen in the oxygen and air tanks
- Flow setting
- CPAP setting
- Position of the  $F_{I}O_2$  control
- Mode selected

**NOTE:** Always use full oxygen and air tanks before the start of any transport. The calculation of any expected run time becomes unreliable as tank pressure is reduced.

The relative amount of oxygen and air used is dependent on the  $F_{I}O_2$  setting. At 60% oxygen, the oxygen and air tanks will be depleted at the same rate. Lower concentrations of oxygen will result in more air used than oxygen. Higher than 60% will result in more oxygen used than air. Also, operation of the IMV + CPAP mode will result in slight greater consumption of oxygen and air, due to the oxygen use by the pneumatic timing system.

The following table shows the expected operating times under the following condition:

- Full “E” size tanks (USA – 660 liters pressurized)
- IMV + CPAP mode
- Inspiratory time – 0.6 seconds
- Expiratory time – 2.0 seconds
- CPAP – 5 cm H<sub>2</sub>O

<u>Flow</u>	<u>21%</u>	<u>60%</u>	<u>100%</u>
6 L/m	100 min	100 min	60 min
10 L/m	60 min	80 min	45 min
15 L/m	40 min	60 min	30 min

## MRI Compatibility

The ventilator was engineered and built to be MRI compatible. Testing in a MRI scanner has shown that the scanner does not affect the ventilator’s performance. The ventilator does not generate artifact, RF noise, or other deleterious effects on the operation of the MRI scanner or it's production of an image. In addition, due to **pNeuton mini** ventilator components, heating of the ventilator does not occur during scanning.

Testing for MRI compatibility was done following ASTM MRI safety standards F2052 – 06e1 and F2119 – 07. The MRI scanner used has the following maximum performance levels:

- Static field strength - 3 Tesla
- Spatial field gradient - 720 G/cm

The scanner used for testing was an active shielded system. The ventilator was placed in the position of maximum field strength and maximum spatial gradient. The standard patient circuit (Airon part number 58031) was used. A standard imaging sequence with a maximum scanning time of 5 minutes was used.



The **pNeuton mini** ventilator meets testing requirements for use within the Magnetic Resonance Environment with a conditional marking for safety.

**NOTE:** Airon recommends that users perform the above referenced tests in their MRI scanner prior to patient use.



**WARNING:** While tests show that the ventilator functions at the bore of the MRI unit, Airon Corporation does not recommend that the ventilator be clinically used at or within the bore of MRI scanners. A minimum proximity of 12 inches (0.3 meter) from the bore should be used. In addition, safe MRI practice calls for all devices used in the proximity of a MRI scanner be anchored to prevent inadvertent movement.

## High Pressure Alarm

The High Patient Pressure alarm ( $P_{ALARM}$ ) will provide an audible and visual alarm when pressure reaches the control’s set level. The range is 10 to 70 cm H<sub>2</sub>O. The control can be set independently of the Peak Pressure control. If it is set less than the Peak Pressure control and patient pressure reaches the alarm level, it will alarm at every breath. Setting the High Pressure alarm control to a slightly higher level than the Peak Pressure control will notify the operator only when there is inadvertent high patient pressure.

The alarm system uses the proximal patient pressure signal. It is inline with the pressure gauge so that the pressure shown on the gauge is the same as the alarm system uses. The sensing line to the patient wye is constantly flushed by a very small flow of oxygen to maintain patency.



This alarm is part of the ventilator's alarm system and is connected to the remote alarm output. This remote alarm output provides a passive, non-electrically charged remote alarm signal on the rear of the ventilator. The remote output uses a normally closed signal output with a resistance of 51K Ohms. When an alarm occurs, the signal output opens to infinite resistance. This is a passive remote alarm output that does not provide its own electrical signal. Use the Airon Remote Alarm (Part number 21031) to provide a remote audible and visual indication of active alarm conditions.

### **Disconnect Alarm**

The ventilator has an internal patient circuit disconnect alarm system. This system cannot be turned off. If a circuit disconnect is sensed, the visual indicator on the front panel will illuminate and the audible alarm will sound.

This alarm system is always on and monitoring pressure in the circuit. Whenever circuit pressure drops below 3 cm H<sub>2</sub>O an independent pressurized capacitance begins to drop in pressure. If a return to at least 3 cm H<sub>2</sub>O pressure does not occur within 10 seconds the pressure in the capacitance drops low enough to activate the audible and visual alarm system.

The alarm will activate as soon as an oxygen source is turned on to the ventilator. Attaching the ventilator to a test lung or the patient and starting ventilation or CPAP will automatically reset the alarm system and turn off the audible and visual indicators.

The alarm system can be momentarily silenced by pressing the Reset / Silence button on the front panel. Pressing this button turns off the visual and audible indicators for 25 seconds. Each time the Reset / Silence

button is pressed; the alarm system restarts the 25 second silence time delay. This delay is NOT cumulative. In other words, repeatably pressing the Reset / Silence button will not increase the silence time by more than 25 seconds.

The alarm system is entirely pneumatic and uses no electricity. A series of valves and pneumatic capacitances provide the sensing network. Due to the nature of this system, a minimum CPAP of 3 cm H<sub>2</sub>O is required. If CPAP is set for less than 3 cm H<sub>2</sub>O and mandatory breaths are not being provided, the alarm system will activate.

This alarm is also connected to the remote alarm system described above. When a disconnect alarm is activated, a remote alarm signal is sent. Use the Airon Remote Alarm (Part number 21031) to provide a remote audible and visual indication of active alarm conditions.

### **Low Gas Supply Alarm**

The Low Gas Supply Alarm will occur if the driving gas supply (Air or Oxygen) drops below safe levels (40 psi, 280 kPa, 2.8 bar). Supply pressures are monitored independently so that if only one supply is low, the alarm will still activate. The alarm activates as long as driving gas is available or until the supply pressure returns to normal.

When operating from cylinders the ventilator will gradually use up the gas and tank pressures will fall. Once one of the cylinders reach approximately 500 psi (35 bar), most portable tank regulators will start to decrease pressure to the ventilator during mandatory breaths. As this happens the at Low Gas Supply Alarm will sense the decreased pressure and begin to intermittently alarm each time the pressure drops during inspiration. As pressure in the cylinder falls to lower values, the amount of time the regulator is delivering low pressure increases and the

alarm sounds longer. Eventually the regulator is unable to maintain pressure and the alarm will sound continuously until all gas in all cylinders is used.

**Note:** The Low Gas Supply Alarm will only activate for a very short period of time if the gas supply abruptly ceases. This can occur if operating from a wall source and the gas supply hoses are disconnected from the gas supply outlet. In fact, the Low Gas Supply Alarm may not sound at all when the ventilator is disconnected from a wall source. This is because all gas in the high pressure hose immediately exits out from where the hose was connected to the outlet and there is no gas pressure to power the ventilator's alarm. When using the ventilator on a patient always insure that the supply gas is secure and operating at the proper pressure.

A differential pressure gas supply alarm is included to ensure proper performance and calibration of the internal air / oxygen blender. The alarm condition will trigger if the pressure differential between the air and oxygen sources to the blender is approximately 18-22 psi.

## Section 8: Troubleshooting

This troubleshooting guide lists common problems that may be encountered and possible solutions. If none of the corrective actions seem to work, contact Airon Corporation or your distributor.

Indication	Meaning	Corrective Action
Ventilator does not operate – no patient ventilation	Missing or insufficient driving gas supply	Check gas source, 55 psi (380 kPa) at 25 L/min is required
	Patient circuit disconnection	Reconnect patient circuit
	Internal malfunction	Send ventilator for service
Ventilator seems to “want” to operate, but no breaths are generated	Peak Pressure control set too low	Increase Peak Pressure control
	Expiratory Time (T <sub>E</sub> ) set too long	Decrease Expiratory Time
	Proximal pressure line disconnected	Ensure tubing is properly connected
	Expiratory valve drive line disconnected	Ensure tubing is properly connected
	Expiratory Valve is malfunctioning	Replace patient circuit
	Insufficient driving gas supply	Check gas source, 55 psi (380 kPa) at 25 L/min is required
	Internal malfunction	Send ventilator for service
Ventilator appears to be stuck in inspiration	CPAP may be turned on high	Check CPAP control
	Internal malfunction	Send ventilator for service

Indication	Meaning	Corrective Action
Ventilator stops and starts	Insufficient driving gas supply	Check gas source, 55 psi (380 kPa) at 25 L/min is required
Lower minute volume than desired	Insufficient driving gas supply	Check gas source, 55 psi (380 kPa) at 25 L/min is required
	Leak in the Patient Circuit or Expiratory Valve	Replace patient circuit
	Obstruction of gas output	Check or replace patient circuit
	Use in hyperbaric condition	Ventilator should not be used in hyperbaric conditions
	Inspiratory Time or Flow control out of calibration	Send ventilator for service
Higher minute volume than desired	Internal malfunction	Send ventilator for service
	Use at higher altitude then calibration	Use external spirometer to verify tidal volume
	Inspiratory Time or Flow control out of calibration	Send ventilator for service
Patient pressure too high	Internal malfunction	Send ventilator for service
	Flow set too high	Decrease Flow or Peak Pressure setting
	Patient response	ET-Tube may be occluded or patient may be biting tube
	Expiratory Valve malfunctioning	Replace patient circuit
Can't get the PEEP / CPAP desired	Internal malfunction	Send ventilator for service
	Expiratory Valve malfunctioning	Replace patient circuit

Indication	Meaning	Corrective Action
Can't get the PEEP / CPAP desired (cont.)	Using a circuit not recommended by Airon	Replace patient circuit
	Internal malfunction	Send ventilator for service
	Excessive "chattering" of CPAP system	Occurs when using some test lungs but will not when connected to a patient. If problem persists, send ventilator for service
Ventilator using too much gas	Leak at source gas	Check hoses and tank regulator for leaks
	Internal leaks	Send ventilator for service
Oxygen concentration too low	Source gas not 100% oxygen	Ensure source gas is 100% oxygen
	Internal malfunction	Send ventilator for service
Alarm activated	Patient circuit disconnection	Reattach circuit or locate leak
	High pressure in circuit	Check patient and adjust High Pressure Alarm as needed
	Alarms at start-up when gas is supplied to ventilator	Normal operation. To silence alarm, attach patient (or test lung) or press Reset / Silence button
	Expiratory valve or proximal pressure tubing disconnected	Ensure tubing is connected properly
	Leak in the Patient Circuit or Expiratory Valve	Replace patient circuit

Indication	Meaning	Corrective Action
Alarm activated (cont.)	Insufficient driving gas supply – alarm sounds briefly during each mandatory breath	Tank may be low. Check gas source, 55 psi (380 kPa) at 25 L/min is required
	Mandatory Breaths OFF and CPAP set to less than 3 cm H <sub>2</sub> O	Set CPAP to at least 3 cm H <sub>2</sub> O or Mandatory Breaths ON
	Excessive patient effort	If peak pressure does not reach 3 cm H <sub>2</sub> O due to patient insp effort during mandatory breaths, alarm will sound. This is normal operation
	Internal malfunction	Send ventilator for service
Alarm does NOT activate	Patient circuit occluded	Check circuit
	Expiratory valve drive line kinked or occluded	Check / replace patient circuit
	Internal malfunction	Send ventilator for service
Visual alarm activates but audible does not	Internal malfunction	Send ventilator for service

## Section 9: Cleaning and Maintenance

### **Cleaning the Ventilator**

- Use only mild detergent or disinfectant and water with a soft cloth.
- Do not immerse the ventilator in water.
- Do not attempt to sterilize the ventilator with autoclave or ethylene oxide. Severe damage to the ventilator may occur.

### **Cleaning / Disinfecting the Patient Circuit**

The Airon patient circuit is a disposable, single use device. This circuit must not be cleaned, disinfected or reused. See Single-Use only Medical Device information, page 5-3.

### **Routine Maintenance**

Airon Corporation recommends that an Operational Verification Test (see Section 4) be performed at initial installation and prior to use on each patient. Institution's standards may require additional biomedical surveillance. No additional routine maintenance is required.

### **Factory Preventative Maintenance**

- Ventilator service is required every 2 years to ensure continuous safety and reliability of the ventilator.
- Ventilator service includes:
  - Replacement of internal filters
  - Replacement of internal materials subject to wear
  - Reconditioning of the enclosure
  - Full maintenance on the internal oxygen blender
  - Complete calibration

- This service must only be performed by Airon Corporation or an Airon approved service technician.
- Failure to perform this service may result in malfunctioning of the ventilator.

## Section 10: Specifications

### General Description

- Pneumatically operated ventilator provides automatic mechanical ventilation with a built-in PEEP / CPAP continuous flow system for spontaneous breathing
- Patient ranges: neonate to child, 400 g to 25 kg.
- Equipment not suitable for use in the presence of flammable anesthetics
- Rated for continuous operation

### Ventilator System Performance

- Controls
  - Mode IMV + CPAP or CPAP
  - Inspiratory Time from 0.25 to 2.0 seconds
  - Expiratory Time from 0.25 to 20 seconds
  - Continuous Flow 6, 8, 10, 15, 20 L/min
  - Peak Pressure from 15 to 60 cm H<sub>2</sub>O
  - PEEP / CPAP from 0 to 20 cm H<sub>2</sub>O
  - % Oxygen 21 to 100%
- Operating Ranges
  - Tidal Volume 20 to 500 ml
  - Respiratory Rate 3 to 120 breaths per minute
  - Minute Volume 0.1 to 15 L/min
  - Internal P Limit 80 cm H<sub>2</sub>O
- Accuracy of Controls
  - Inspiratory Time  $\pm 10\%$
  - Expiratory Time  $\pm 10\%$
  - Continuous Flow  $\pm 10\%$
  - Peak Pressure  $\pm 2$  cm H<sub>2</sub>O
  - PEEP / CPAP  $\pm 2$  cm H<sub>2</sub>O
  - F<sub>I</sub>O<sub>2</sub>  $\pm 3\%$

- Precision - breath to breath repeatability of controls
  - Inspiratory Time  $\pm 10\%$
  - Expiratory Time  $\pm 10\%$
  - Continuous Flow  $\pm 10\%$
  - Peak Pressure  $\pm 5$  cm H<sub>2</sub>O
  - PEEP / CPAP  $\pm 2$  cm H<sub>2</sub>O
  - F<sub>I</sub>O<sub>2</sub>  $\pm 3\%$
- Specificity - effect of one control on another
  - Inspiratory Time  $\pm 5\%$
  - Expiratory Time  $\pm 5\%$
  - Continuous Flow  $\pm 5\%$
  - Peak Pressure  $\pm 5\%$
  - PEEP / CPAP  $\pm 5\%$
  - F<sub>I</sub>O<sub>2</sub>  $\pm 3\%$
- Internal Compliance - 0.1 ml/cm H<sub>2</sub>O
- Ventilator Resistance to Flow
  - Inspiratory, 15 L/min: less than 1 cm H<sub>2</sub>O
  - Expiratory, 15 L/min: less than 1.2 cm H<sub>2</sub>O

### Alarm System

- Patient Disconnect
  - Pressure: less than 3 cm H<sub>2</sub>O
  - Alarm delay: 10 seconds
  - Alarm silence: 25 seconds
- Low Gas Supply – gas input Oxygen and Air
  - Input supply pressure: less than 40 psi (2.8 bar) or pressure differential 15 psi (1.0 bar)
  - Cannot be silenced
- High Pressure
  - Peak Pressure adjustment

## Environmental and Physical Characteristics

- MRI Conditional. Tested with a scanner up to:
  - Maximum static field strength - 3 T
  - Maximum spatial field gradient - 720 G/cm
- Hypobaric (high altitude) compatible up to 15,000 feet (4,600 meters)
- Weight and Size: 9 pounds (4 kg), 6.0"H x 8.7"W x 7.8"D (15.2 cm x 22.1 cm x 19.8 cm)
- Storage Temperature Range: -47 to 71 °C (-52 to 160 °F), 15 to 95 percent humidity, noncondensing
- Operating Temperature Range: -15 to 49 °C (5 to 120 °F), 15 to 95 percent humidity, noncondensing

## Power Sources

- Driving gas requirement
  - 55 psi  $\pm$  15 psi (380 kPa  $\pm$  100 kPa)
  - 100% oxygen and medical grade air. Do not use the ventilator with other types of gases. Do not use compressed air that is contaminated with any water or other materials.
  - Both gas supplies must be capable of delivering at least 25 liters per minute at 55 psi. If either input pressure drops less than 40 psi due to insufficient gas flow, the ventilator will alarm and begin to malfunction.

**NOTE:** Internal oxygen consumption equals 3 L/min oxygen when set for IMV + CPAP mode

## Section 11: Limited Warranty

AIRON CORPORATION, through its Official Distributor, warrants this product to be free from defects in construction, material and workmanship for a period of twelve (12) months from the date of original delivery to buyer when operated properly under conditions of normal use for which the product is intended. This twelve (12) month warranty does not extend to expendable items such as membranes, hoses, patient circuits and filters, which are warranted to be free of defects only at time of original delivery.

The official AIRON CORPORATION Distributor will, at its option, either repair or replace any defective product, as above defined, which is reported to that AIRON CORPORATION Distributor within 72 hours of occurrence during the warranty period. If so instructed by the Distributor, such defective products must be returned to the official AIRON CORPORATION Distributor in the original container with freight charges prepaid. In any case, AIRON CORPORATION shall be responsible for repairs to, or replacement of, such defective product only.

### LIMITATIONS ON AND DISCLAIMER OF WARRANTIES:

AIRON CORPORATION shall be relieved of any liability under this warranty: if the product is not used in accordance with manufacturer's instructions; if attachment or incorporation of any device is made to this product without written approval; if use is made in any manner other than intended by the manufacturer; if regular periodic maintenance and service is not performed; if repairs are made by other than authorized AIRON CORPORATION service personnel; if the product has been subject to abuse, misuse, negligence or accident. Any product that has been mechanically or electronically altered without

specific written authorization from AIRON CORPORATION is also excluded from this warranty.

The warranty described in this Agreement is in lieu of all other warranties. THE PARTIES AGREE THAT THE IMPLIED WARRANTIES OF MERCHANTABILITY AND FITNESS FOR A PARTICULAR PURPOSE AND ALL OTHER WARRANTIES, EXPRESS OR IMPLIED, ARE EXCLUDED FROM THIS AGREEMENT.

Except as stated above, AIRON CORPORATION SHALL NOT BE LIABLE FOR ANY DAMAGES, CLAIMS OR LIABILITIES INCLUDING, BUT NOT LIMITED TO, PERSONAL BODILY INJURY, OR INCIDENTAL, CONSEQUENTIAL, and OR SPECIAL DAMAGES.



## Section 12: Index

- A**
  - Administering Oxygen 4-6
  - Air, Medical
    - Driving Gas Inlet 3-5
    - Driving Supply Requirements 10-3
    - Tank, Expected Operating Time 7-6
  - Airway Connection Port 3-5
  - Alarms
    - High Patient Pressure 3-7, 4-2, 7-8, 10-2
    - High Pressure Release 3-6
    - Low Gas Supply 3-6, 4-2, 7-10, 10-2
    - Patient Disconnect 3-7, 4-7, 7-9, 10-2
  - Altitude Operation 2-4, 4-8
  - Anti-Suffocation System 3-6
- C**
  - Cautions 2-3
  - Circuit, Patient Breathing
    - Cleaning 9-1
    - Configuration 5-1
    - Connection 5-2
  - Cleaning
    - Patient Breathing Circuit 9-1
    - Ventilator 9-1
  - Contraindications 1-2
  - Controls
    - % Oxygen 3-3
    - Expiratory Time 3-3
    - Flow 3-2
    - High Pressure Alarm 3-4
    - Inspiratory Time 3-2
    - Mode 3-1
    - Peak Pressure 3-2
    - PEEP / CPAP 3-2
    - Tidal Volume 3-2
  - Continuous Flow - CPAP 7-4
- CPAP
  - Control 3-2, 4-6
  - Functional Operation 7-4
- D**
  - Disconnect Alarm 3-7, 4-7, 7-9
- E**
  - Expiratory Time Control 3-3, 4-4
  - Expiratory Valve
    - Connection 3-5, 5-2
    - Relationship to CPAP System 7-4
- F**
  - Flow, Inspiratory Control 3-2, 4-5
  - Front Panel 3-1
- H**
  - High Altitude Operation 4-8
  - High Patient Pressure Alarm 3-7, 4-2
    - Control 3-4, 4-6
    - Functional Operation 7-8
  - High Pressure Release 3-6
  - Hyperbaric Operation 2-3
  - Hypobaric Operation 2-4, 4-8
- I**
  - Indications For Use 1-1
  - Infant Patient Circuit 5-1
  - Inspiratory Time Control 3-2, 4-4
  - Internal Patient Safety Systems 3-7
- L**
  - Low Gas Supply Alarm 3-6, 4-2, 7-10
- M**
  - Maintenance - Ventilator Service 9-1
  - Management of Patient Tidal Volume 7-3
  - Mandatory Breaths
    - Inspiratory and Expiratory Time Controls 4-4

Medical Symbol Key 2-7  
Mode of Operation 2-2, 4-3, 7-1  
MRI Compatibility 2-3, 2-5, 2-7, 7-7, 10-3

## **N**

Notes 2-4

## **O**

Operation, Inspiratory and Expiratory Time Controls 4-4  
Operational Verification 4-2  
Oxygen  
    % Oxygen Control 3-3, 4-6  
    Driving Gas Inlet 3-4  
    Driving Supply Requirements 10-3  
    Operational Characteristics 7-5  
    Tank, Expected Operating Time 7-6

## **P**

Patient Circuit  
    Cleaning 9-1  
    Configuration 5-1  
    Connection 3-5  
    Connecting to Ventilator 5-2  
    Disconnect Alarm 3-7 4-7  
    Single Use 5-3  
Patient Ventilation 4-3  
Peak Pressure Control 3-2, 4-5  
Pediatric Patient Circuit 5-1  
Performance Verification 4-2  
PEEP / CPAP  
    Control 3-2, 4-6  
    Functional Operation 7-4  
Pneumatic System 7-2  
Pneumatic Low Gas Supply Alarm 3-6  
Power Requirements - Driving Gas Supply 10-3  
Pressure  
    Peak Pressure Control 3-2  
    PEEP / CPAP Control 3-2  
    High Pressure Alarm 3-4

Pressure Gauge 3-1  
Preventative Maintenance 9-1  
Principles of Operation  
    CPAP Demand Flow Breathing System 7-4  
    Management of Patient Tidal Volume 7-3  
    Oxygen Delivery System 7-5  
    Pneumatic System Diagram 7-1  
    Pneumatic System Description 7-2

## **R**

Remote Alarm Output 3-5  
Respiratory Rate  
    Expiratory Time Control 3-3  
    Inspiratory Time Control 3-2  
    Inspiratory and Expiratory Time Controls 4-4

## **S**

Safety Systems 3-6  
Set Up, Ventilator 4-1  
Service, Preventative Maintenance 9-1  
Side Panel 3-4  
Single-Use only Devices/Accessories 5-3  
Specifications  
    Alarm System 10-2  
    Environmental and Physical Characteristics 10-3  
    General Description 10-1  
    Power Sources 10-3  
    Ventilator System Performance 10-1  
Symbol Key 2-7

## **T**

Tanks, Expected Operating Time 7-6  
Tidal Volume, Management 7-3  
Theory of Operation  
    CPAP Demand Flow Breathing System 7-4  
    Management of Patient Tidal Volume 7-3  
    Oxygen Delivery System 7-5  
    Pneumatic System Diagram 7-1  
    Pneumatic System Description 7-2

Troubleshooting Ventilator 8-1

**U**

Unique Device Identifier (UDI) 3-6

**V**

Ventilator, General Description 1-1

Cleaning and Maintenance 10-1

Connection 5-2

Set-up 4-1

Verification, Operational 4-2

**W**

Warnings 2-1

Warranty 11-1